

Article number: 20193V25V25502BL
 Description: E+G T-angle clamp
 GN 193-V25-V25-50-2-BL

Measures

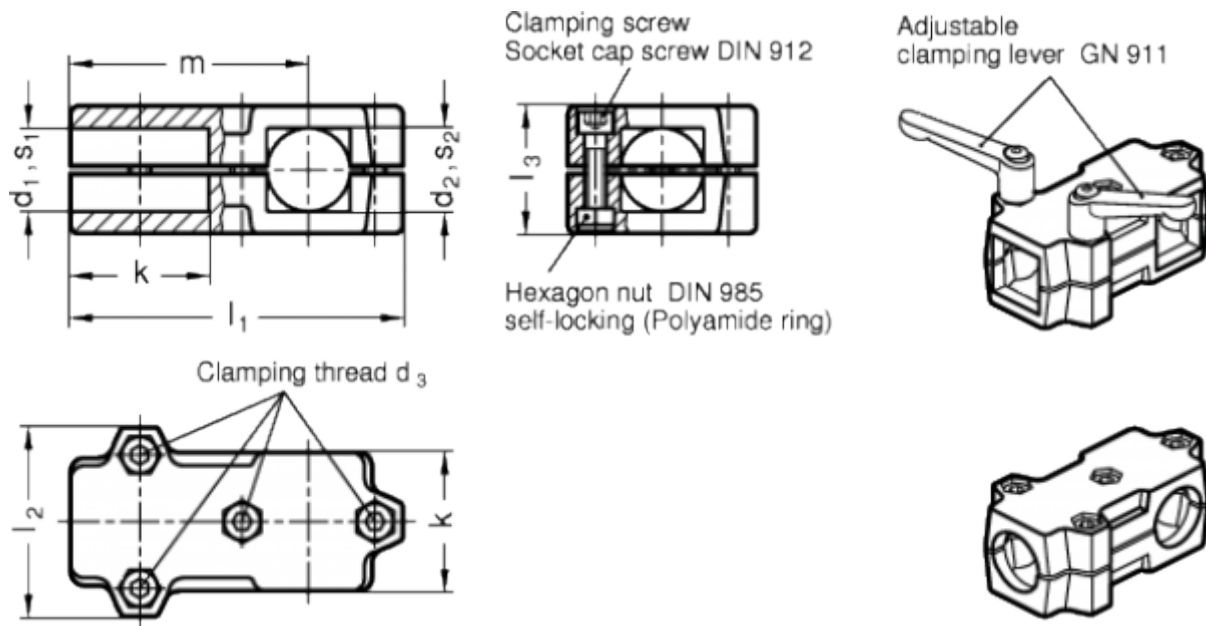

Accessories = GN 911-M8-40	m	= -
d1 = -	s1	= 25
d2 = -	s2	= 25
d3 = M8	Weight in (g)	= 420
k = 50		
l1 = 120		
l2 = 68		
l3 = 46		